

Table Top Rack Cabinets Heavy Duty - Ventilated (RCHV Series)



Features:









- Heavy duty, 16-gauge steel, 19" table top rack cabinet...
- Ventilated on both sides & optimized per size to allow natural air convection...
- For solid side versions link to our [RCHS series](#)...
- Panel rails are infinitely adjustable (front to back), round hole punched for 10-32 clip-nuts to full EIA hole centers (5/8 - 5/8 - 1/2 inch spacing)...
- Includes two pairs of rails (for rear support of heavier equipment), rubber feet, black ABS plastic handles, a starter pack of 10-32 clip nuts & matching 1421ABK black screws...
- Supplied unassembled (four cabinet pieces & four rails), shipped in a flat pack container for handling ease & protection (see photo below)...
- Simple assembly using one bolt in each corner to lock the sides to the top and bottom (hardware included)...
- Overall width 21"...
- Overall height 2" over panel space...
- Front & back lip is .585" so usable depth is reduced by 1.17"
- Recommended maximum weight (RCHV1902824 tested) - 800 pounds...
- Rugged textured powder paint finish...
- Stocked in Black & Light Gray (RAL7035)...

17.5" Deep models:











| Part Number | Color | PDF Reader File | AutoCAD .dxf File (zipped) | Panel Height | | Number of Clip Nuts & Screws Included | Wt. lbs. |
|--|------------------------------|-----------------|----------------------------|--------------|-------|---------------------------------------|----------|
| | | | | Inches | Units | | |
| RCHV1900817BK1 RCHV1900817CG1 RCHV1900817LG1 | Black Beige Light Gray | 75K | 79K | 8.75 | 5 | 8 | 38 |
| RCHV1901017BK1 RCHV1901017CG1 RCHV1901017LG1 | Black Beige Light Gray | 75K | 80K | 10.50 | 6 | 16 | 40 |
| RCHV1901417BK1 RCHV1901417CG1 RCHV1901417LG1 | Black Beige Light Gray | 102K | 109K | 14.00 | 8 | 16 | 44 |
| RCHV1901717BK1 RCHV1901717CG1 RCHV1901717LG1 | Black Beige Light Gray | 113K | 124K | 17.50 | 10 | 16 | 50 |
| RCHV1902217BK1 RCHV1902217CG1 RCHV1902217LG1 | Black Beige Light Gray | 116K | 128K | 22.75 | 13 | 16 | 54 |
| RCHV1902817BK1 RCHV1902817CG1 RCHV1902817LG1 | Black Beige Light Gray | 114K | 129K | 28.00 | 16 | 16 | 60 |

24.5" Deep models:



| Part Number | Color | PDF Reader File | AutoCAD .dxf File | Panel Height | | Number of Clip Nuts & Screws Included | Wt. lbs. |
|--|------------------------------|-----------------|-------------------|--------------|-------|---------------------------------------|----------|
| | | | | Inches | Units | | |
| RCHV1901024BK1 RCHV1901024CG1 RCHV1901024LG1 | Black Beige Light Gray | 91K | 94K | 10.50 | 6 | 16 | 52 |
| RCHV1901424BK1 RCHV1901424CG1 RCHV1901424LG1 | Black Beige Light Gray | 121K | 136K | 14.00 | 8 | 16 | 58 |
| RCHV1901724BK1 RCHV1901724CG1 | Black Beige | | | 17.50 | 10 | 16 | 62 |

| | | | | | | | |
|-----------------------|------------|---|--|--------------|----|----|----|
| RCHV1901724LG1 | Light Gray | 125K | 141K | | | | |
| RCHV1902224BK1 | Black |  |  | 22.75 | 13 | 16 | 70 |
| RCHV1902224CG1 | Beige |  |  | | | | |
| RCHV1902224LG1 | Light Gray | 124K | 149K | | | | |
| RCHV1902824BK1 | Black |  |  | 28.00 | 16 | 16 | 78 |
| RCHV1902824CG1 | Beige |  |  | | | | |
| RCHV1902824LG1 | Light Gray | 124K | 152K | | | | |

31.5" Deep models:

| Part Number | Color |  Reader File | AutoCAD .dxf File | Panel Height | | Number of Clip Nuts & Screws Included | Wt. lbs. |
|--|---------------------|---|---|--------------|-------|---------------------------------------|----------|
| | | | | Inches | Units | | |
| RCHV1901031BK1 RCHV1901031LG1 | Black Light Gray |  97K |  108K | 10.50 | 6 | 16 | 64 |
| RCHV1901431BK1 RCHV1901431LG1 | Black Light Gray |  133K |  164K | 14.00 | 8 | 16 | 68 |
| RCHV1901731BK1 RCHV1901731LG1 | Black Light Gray |  145K |  176K | 17.50 | 10 | 16 | 74 |
| RCHV1902231BK1 RCHV1902231LG1 | Black Light Gray |  149K |  184K | 22.75 | 13 | 16 | 86 |
| RCHV1902831BK1 RCHV1902831LG1 | Black Light Gray |  152K |  191K | 28.00 | 16 | 16 | 94 |

Feature Views:

| | |
|---|---|
| <p>Ships Flat For Handling Ease & Protection</p>  <p>Wood Ends Corner protectors nailed to wood ends Banded</p> | <p>Interior View With Infinitely Adjustable Panel Rails</p>  <p>Rails are infinitely adjustable (front to back) on amhnl struts Base punched for easy caster mounting</p> |
| <p>Panel Rails (Two Pair Included) With 10-32 Black Clip Nuts & Mounting Hardware</p>  | |

Accessories:



Castors - Part Number 1425PHD

- **SOLD IN A SET OF 4**
- Base of cabinet is punched to accept this caster set
- 600# Mfg's specified weight capacity (Set of 4)
- Features ball bearing swivel and hard composition wheels
- Small foot print 2.125" x 15/16" hole mounting pattern
- Wheels are grey & 2" wheel diameter
- Includes mounting hardware



Doors

- 16-gauge steel construction
- Both front & back of "RCHV" rack cabinets are punched to accept these doors
- Mounts either right or left hand hinge (door & cabinet are symmetrical)
- Includes installed lock and two keys
- Finished in rugged textured powder paint to match RCHS/RCHV enclosures
- Includes mounting hardware



| Part Number | Color | PDF Reader File | AutoCAD .dxf File | Use With Cabinet Panel Height | Wt. lbs. |
|--|------------------------------|-----------------|-------------------|-------------------------------|----------|
| RCHD1908BK1 RCHD1908CG1 RCHD1908LG1 | Black Beige Light Gray | 17K | 179K | 8" (5 U) | 5 |
| RCHD1910BK1 RCHD1910CG1 RCHD1910LG1 | Black Beige Light Gray | 18K | 192K | 10.5" (6 U) | 5 |
| RCHD1914BK1 RCHD1914CG1 RCHD1914LG1 | Black Beige Light Gray | 19K | 219K | 14" (8 U) | 6 |
| RCHD1917BK1 RCHD1917CG1 RCHD1917LG1 | Black Beige Light Gray | 21K | 246K | 17.5" (10 U) | 7 |
| RCHD1922BK1 RCHD1922CG1 RCHD1922LG1 | Black Beige Light Gray | 22K | 285K | 22.75" (13 U) | 9 |
| RCHD1928BK1 RCHD1928CG1 RCHD1928LG1 | Black Beige Light Gray | 24K | 329K | 28" (16 U) | 12 |



Extra Panel Rails

- RCHV rack cabinets ship with two pair - order below for extra mounting capabilities
- **Sold in pairs**
- Finished in rugged black textured powder paint
- Includes amhal strut mounting hardware (black clip nuts are not included)

| Part Number | Use With Cabinet Panel Height |
|-----------------|-------------------------------|
| RCHR1908 | 8" (5 U) |
| RCHR1910 | 10.5" (6 U) |
| RCHR1914 | 14" (8 U) |
| RCHR1917 | 17.5" (10 U) |
| RCHR1922 | 22.75" (13 U) |
| RCHR1928 | 28" (16 U) |



Extra Spring Nuts - Part Number **1421SN**

- 1/4 - 20 Strut nut
- 1/4 - 20 x 1/2 bolt
- Used only in our RCHS & RCHV table top rack cabinets - handy for mounting of other

- equipment to the horizontal struts
- **Sold in packages of 8 (8 spring nuts and 8 bolts) as shown**



Replacement Rubber Feet - Part Number **1421RC24**

- RCHV rack cabinets ship with four feet included - order these for replacement
- **Sold in package of 20**



PART No. RCHV1902231

for more information visit
www.hammfg.com

Data subject to change without notice.
Isometric drawing not to scale.
Shipped knockdown for handling ease
& protection.

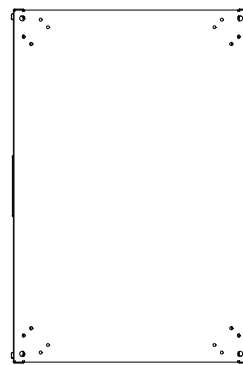
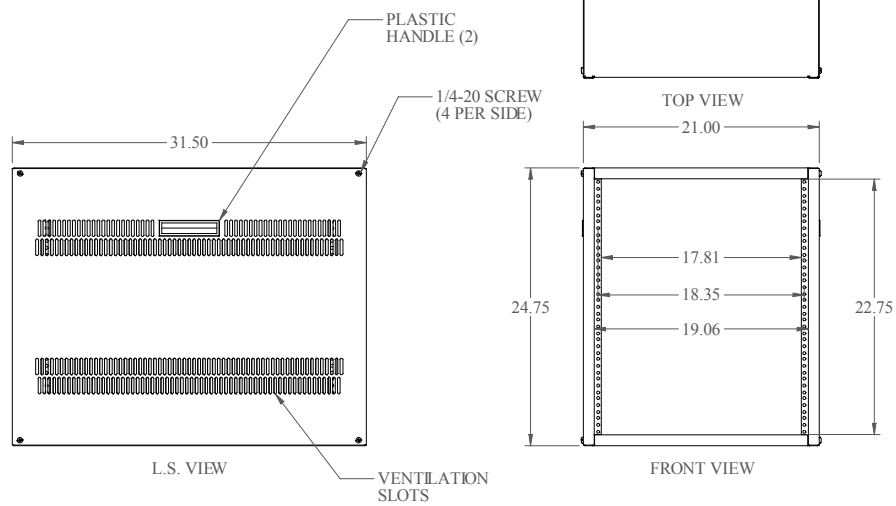
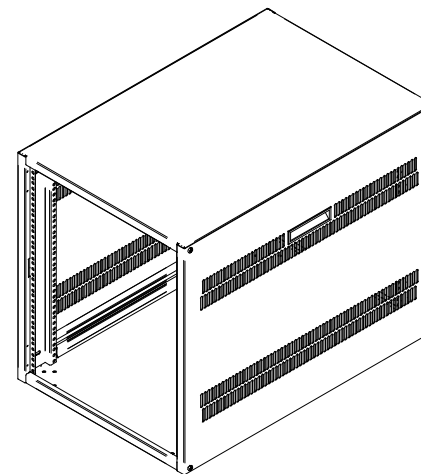

BOTTOMVIEW